

l -adic images of Galois for elliptic curves over \mathbb{Q}

David Zureick-Brown

Emory University

arXiv:2160.11141

with Jeremy Rouse and Andrew V. Sutherland
and an appendix with John Voight

Diophantine Geometry Program Research Seminar
Simons Laufer Mathematical Sciences Institute

April 20, 2023

Slides available at <http://www.math.emory.edu/~dzb/slides/>

Galois Representations

$$\begin{aligned} \mathbb{Q} &\subset K \subset \overline{\mathbb{Q}} \\ G_K &:= \text{Aut}(\overline{K}/K) \\ E[n](\overline{K}) &\cong (\mathbb{Z}/n\mathbb{Z})^2 \end{aligned}$$

$$\begin{aligned} \rho_{E,n}: G_K &\rightarrow \text{Aut } E[n] \cong \text{GL}_2(\mathbb{Z}/n\mathbb{Z}) \\ \rho_{E,\ell^\infty}: G_K &\rightarrow \text{GL}_2(\mathbb{Z}_\ell) = \varprojlim_n \text{GL}_2(\mathbb{Z}/\ell^n\mathbb{Z}) \\ \rho_E: G_K &\rightarrow \text{GL}_2(\widehat{\mathbb{Z}}) = \varprojlim_n \text{GL}_2(\mathbb{Z}/n\mathbb{Z}) \end{aligned}$$

Serre's Open Image Theorem

Theorem (Serre, 1972)

Let E be an elliptic curve over K without CM. The image

$$\rho_E(G_K) \subset \mathrm{GL}_2(\widehat{\mathbb{Z}})$$

of ρ_E is open.

Note:

$$\mathrm{GL}_2(\widehat{\mathbb{Z}}) \cong \prod_{\ell} \mathrm{GL}_2(\mathbb{Z}_{\ell})$$

Thus ρ_{E,ℓ^∞} is surjective for all but finitely many ℓ .

For CM curves, see Lozano-Robledo's [paper](#) and work by Bourdon, Clark, and Pollack.

Image of Galois

$$\rho_{E,n}: G_{\mathbb{Q}} \rightarrow H(n) \hookrightarrow \mathrm{GL}_2(\mathbb{Z}/n\mathbb{Z})$$

$$G_{\mathbb{Q}} \left\{ \begin{array}{c} \overline{\mathbb{Q}} \\ | \\ \overline{\mathbb{Q}}^{\ker \rho_{E,n}} = \mathbb{Q}(E[n]) \\ | \\ \mathbb{Q} \end{array} \right\} H(n)$$

Problem (Mazur's "program B")

Classify all possibilities for $H(n)$.

Mazur's Program B

As presented at Modular functions in one variable V in Bonn

Theorem 1 also fits into a general program:

B. Given a number field K and a subgroup H of $GL_2 \hat{\mathbb{Z}} = \prod_p GL_2 \mathbb{Z}_p$ classify
all elliptic curves E/K whose associated Galois representation on torsion points
maps $\text{Gal}(\bar{K}/K)$ into $H \subset GL_2 \hat{\mathbb{Z}}$.

Mazur - Rational points on modular curves (1977)

Example - torsion on an elliptic curve

If E has a K -rational **torsion point** $P \in E(K)[n]$ (of exact order n) then:

$$H(n) \subset \begin{pmatrix} 1 & * \\ 0 & * \end{pmatrix}$$

since for $\sigma \in G_K$ and $Q \in E(\bar{K})[n]$ such that $E(\bar{K})[n] \cong \langle P, Q \rangle$,

$$\begin{aligned} \sigma(P) &= P \\ \sigma(Q) &= a_\sigma P + b_\sigma Q \end{aligned}$$

Example - Isogenies

If E has a K -rational, **cyclic isogeny** $\phi: E \rightarrow E'$ with $\ker \phi = \langle P \rangle$ then:

$$H(n) \subset \begin{pmatrix} * & * \\ 0 & * \end{pmatrix}$$

since for $\sigma \in G_K$ and $Q \in E(\overline{K})[n]$ such that $E(\overline{K})[n] \cong \langle P, Q \rangle$,

$$\begin{aligned} \sigma(P) &= a_\sigma P \\ \sigma(Q) &= b_\sigma P + c_\sigma Q \end{aligned}$$

Example - other maximal subgroups

Normalizer of a split Cartan:

$$N_{\text{sp}} = \left\langle \left(\begin{array}{cc} * & 0 \\ 0 & * \end{array} \right), \left(\begin{array}{cc} 0 & 1 \\ -1 & 0 \end{array} \right) \right\rangle$$

$H(n) \subset N_{\text{sp}}$ and $H(n) \not\subset C_{\text{sp}}$ iff

- there exists an unordered pair $\{\phi_1, \phi_2\}$ of cyclic isogenies,
- whose kernels intersect trivially,
- neither of which is defined over K ,
- but which are both defined over some quadratic extension of K ,
- and which are Galois conjugate.

Example - other maximal subgroups

$\mathbb{F}_{p^2}^*$ acts on $\mathbb{F}_{p^2} \cong \mathbb{F}_p \times \mathbb{F}_p$

Normalizer of a non-split Cartan:

$$C_{\text{ns}} = \text{im} \left(\mathbb{F}_{p^2}^* \rightarrow \text{GL}_2(\mathbb{F}_p) \right) \subset N_{\text{ns}}$$

$H(n) \subset N_{\text{ns}}$ and $H(n) \not\subset C_{\text{ns}}$ iff

E admits a “necklace” (Rebolledo, Wuthrich)

Image of Galois

$$\rho_{E,n}: G_{\mathbb{Q}} \rightarrow H(n) \hookrightarrow \mathrm{GL}_2(\mathbb{Z}/n\mathbb{Z})$$

$$G_{\mathbb{Q}} \left\{ \begin{array}{c} \overline{\mathbb{Q}} \\ | \\ \overline{\mathbb{Q}}^{\ker \rho_{E,n}} = \mathbb{Q}(E[n]) \\ | \\ \mathbb{Q} \end{array} \right\} H(n)$$

Problem (Mazur's "program B")

Classify all possibilities for $H(n)$.

Modular curves

Definition

- $X(N)(K) := \{(E/K, P, Q) : E[N] = \langle P, Q \rangle\} \cup \{\text{cusps}\}$
- $X(N)(K) \ni (E/K, P, Q) \Leftrightarrow \rho_{E,N}(G_K) = \{I\}$

Let $\Gamma(N) \subset H \subset \text{GL}_2(\widehat{\mathbb{Z}})$. The minimal such N is the **level** of H .

Definition

$X_H := X(N)/H(N)$ (where $H(N)$ is the image of H in $\text{GL}_2(\mathbb{Z}/N\mathbb{Z})$)

$X_H(K) \ni (E/K, \iota) \Leftrightarrow \rho_{E,N}(G_K) \subset H(N)$

Stacky disclaimer

This is only true up to twist; there are some subtleties if

- 1 $j(E) \in \{0, 12^3\}$ (plus some minor group theoretic conditions), or
- 2 if $-I \in H$.

Rational Points on modular curves

Mazur's program B

Compute $X_H(\mathbb{Q})$ for all H .

Remark

- Sometimes $X_H \cong \mathbb{P}^1$ or elliptic with rank $X_H(\mathbb{Q}) > 0$.
- Some X_H have **exceptional** points (i.e, non-cusp non-CM points).
- Can compute $g(X_H)$ group theoretically (via Riemann–Hurwitz).

Fact

$$g(X_H), \gamma(X_H) \rightarrow \infty \text{ as } [\mathrm{GL}_2(\widehat{\mathbb{Z}}) : H] \rightarrow \infty.$$

(Serre) Sample subgroup $H \subset \mathrm{GL}_2(\widehat{\mathbb{Z}})$

$$\begin{array}{ccccc} \ker \phi_2 & \subset & H(8) & \subset & \mathrm{GL}_2(\mathbb{Z}/8\mathbb{Z}) & \dim_{\mathbb{F}_2} \ker \phi_2 = 3 \\ & & \downarrow \phi_2 & & \downarrow & \\ I + 2M_2(\mathbb{Z}/2\mathbb{Z}) & \subset & H(4) & = & \mathrm{GL}_2(\mathbb{Z}/4\mathbb{Z}) & \dim_{\mathbb{F}_2} \ker \phi_1 = 4 \\ & & \downarrow \phi_1 & & \downarrow & \\ & & H(2) & = & \mathrm{GL}_2(\mathbb{Z}/2\mathbb{Z}) & \end{array}$$

$$\chi: \mathrm{GL}_2(\mathbb{Z}/8\mathbb{Z}) \rightarrow \mathrm{GL}_2(\mathbb{Z}/2\mathbb{Z}) \times (\mathbb{Z}/8\mathbb{Z})^* \rightarrow \mathbb{Z}/2\mathbb{Z} \times (\mathbb{Z}/8\mathbb{Z})^* \cong \mathbb{F}_2^3.$$

$$\chi = \mathrm{sgn} \times \det$$

$$H(8) := \chi^{-1}(G), \quad G \subset \mathbb{F}_2^3.$$

A typical subgroup $H \subset \mathrm{GL}_2(\widehat{\mathbb{Z}})$

$$\begin{array}{ccccc} \ker \phi_4 & \subset & H(32) & \subset & \mathrm{GL}_2(\mathbb{Z}/32\mathbb{Z}) & \dim_{\mathbb{F}_2} \ker \phi_4 = 4 \\ & & \downarrow \phi_4 & & \downarrow & \\ \ker \phi_3 & \subset & H(16) & \subset & \mathrm{GL}_2(\mathbb{Z}/16\mathbb{Z}) & \dim_{\mathbb{F}_2} \ker \phi_3 = 3 \\ & & \downarrow \phi_3 & & \downarrow & \\ \ker \phi_2 & \subset & H(8) & \subset & \mathrm{GL}_2(\mathbb{Z}/8\mathbb{Z}) & \dim_{\mathbb{F}_2} \ker \phi_2 = 2 \\ & & \downarrow \phi_2 & & \downarrow & \\ \ker \phi_1 & \subset & H(4) & \subset & \mathrm{GL}_2(\mathbb{Z}/4\mathbb{Z}) & \dim_{\mathbb{F}_2} \ker \phi_1 = 3 \\ & & \downarrow \phi_1 & & \downarrow & \\ & & H(2) & = & \mathrm{GL}_2(\mathbb{Z}/2\mathbb{Z}) & \end{array}$$

Non-abelian entanglements

There exists a surjection $\theta: \mathrm{GL}_2(\mathbb{Z}/3\mathbb{Z}) \rightarrow \mathrm{GL}_2(\mathbb{Z}/2\mathbb{Z})$.

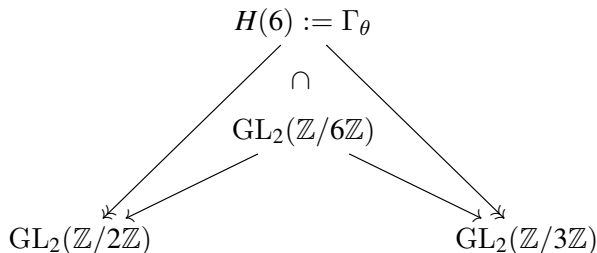

Brau–Jones

$$\mathrm{im} \rho_{E,6} \subset H(6) \Leftrightarrow j(E) = 2^{10}3^3t^3(1 - 4t^3) \Rightarrow K(E[2]) \subset K(E[3])$$
$$X_H \cong \mathbb{P}^1 \xrightarrow{j} X(1)$$

Main conjecture

Conjecture (Serre)

Let E be an elliptic curve over \mathbb{Q} without CM. Then for $\ell > 37$, $\rho_{E,\ell}$ is surjective.

In other words, conjecturally, $\rho_{E,\ell^\infty} = \mathrm{GL}_2(\mathbb{Z}_\ell)$ for $\ell > 37$.

“Vertical” image conjecture

Conjecture

There exists a constant N such that for every E/\mathbb{Q} without CM

$$\left[\mathrm{GL}_2(\widehat{\mathbb{Z}}) : \rho_E(G_{\mathbb{Q}}) \right] \leq N.$$

Remark

This follows from the “ $\ell > 37$ ” conjecture.

Problem

Assume the “ $\ell > 37$ ” conjecture and compute N .

Labeling subgroups of $GL_2(\widehat{\mathbb{Z}})$ up to conjugacy

Definition

When $\det(H) = \widehat{\mathbb{Z}}^\times$ these labels have the form $N.i.g.n$, where N is the level, i is the index, g is the genus, and n is a tiebreaker given by ordering the subgroups of $GL_2(N)$.

Example

- The Borel subgroup $B(13)$ has label $13.14.0.1$.
- The normalizer of the split Cartan $N_{\text{sp}}(13)$ has label $13.91.3.1$.
- The normalizer of the nonsplit Cartan $N_{\text{ns}}(13)$ has label $13.78.3.1$.
- The maximal S_4 exceptional group $S_4(13)$ has label $13.91.3.2$.

Obligatory XKCD cartoon

HOW STANDARDS PROLIFERATE:

(SEE: A/C CHARGERS, CHARACTER ENCODINGS, INSTANT MESSAGING, ETC.)

SITUATION:
THERE ARE
14 COMPETING
STANDARDS.

14?! RIDICULOUS!
WE NEED TO DEVELOP
ONE UNIVERSAL STANDARD
THAT COVERS EVERYONE'S
USE CASES.



SOON:

SITUATION:
THERE ARE
15 COMPETING
STANDARDS.

Main Theorem

Definition

A point $(E, \iota) \in X_H(K)$ is **exceptional** if $X_H(K)$ is finite and $\text{End } E = \mathbb{Z}$.

Theorem (Rouse–Sutherland–ZB 2021)

Let ℓ prime, E/\mathbb{Q} be a non-CM elliptic curve, and $H = \rho_{E, \ell^\infty}(G_{\mathbb{Q}})$.

Then exactly one of the following is true:

- 1 $X_H(\mathbb{Q})$ is infinite and H is listed in (Sutherland–Zywina 2017);
- 2 X_H has a rational exceptional point listed in Table 1;
- 3 $H \leq N_{\text{ns}}(3^3), N_{\text{ns}}(5^2), N_{\text{ns}}(7^2), N_{\text{ns}}(11^2)$, or $N_{\text{ns}}(\ell)$ for some $\ell > 13$;
- 4 H is a subgroup of $49.179.9.1$ or $49.196.9.1$.

We conjecture that cases (3) and (4) never occur.

If they do, the exceptional points have **extraordinarily** large heights (e.g. $10^{10^{200}}$ for $X_{\text{ns}}^+(11^2)(\mathbb{Q})$).

label	level	notes	j -invariants/models of exceptional points
16.64.2.1	2 ⁴	$N_{\text{ns}}(16)$	$-2^{18} \cdot 3 \cdot 5^3 \cdot 13^3 \cdot 41^3 \cdot 107^3 / 17^{16}$ $-2^{21} \cdot 3^3 \cdot 5^3 \cdot 7 \cdot 13^3 \cdot 23^3 \cdot 41^3 \cdot 179^3 \cdot 409^3 / 79^{16}$
16.96.3.335	2 ⁴	$H(4) \subsetneq N_{\text{sp}}(4)$	$257^3 / 2^8$
16.96.3.343	2 ⁴	$H(4) \not\subset N_{\text{sp}}(4)$	$17^3 \cdot 241^3 / 2^4$
16.96.3.346	2 ⁴	$H(4) \not\subset N_{\text{sp}}(4)$	$2^4 \cdot 17^3$
16.96.3.338	2 ⁴	$H(4) \not\subset N_{\text{sp}}(4)$	2^{11}
32.96.3.230	2 ⁵	$H(4) \not\subset N_{\text{sp}}(4)$	$-3^3 \cdot 5^3 \cdot 47^3 \cdot 1217^3 / (2^8 \cdot 31^8)$
32.96.3.82	2 ⁵	$H(8) \not\subset N_{\text{sp}}(8)$	$3^3 \cdot 5^6 \cdot 13^3 \cdot 23^3 \cdot 41^3 / (2^{16} \cdot 31^4)$
25.50.2.1	5 ²	$H(5) = N_{\text{ns}}(5)$	$2^4 \cdot 3^2 \cdot 5^7 \cdot 23^3$
25.75.2.1	5 ²	$H(5) = N_{\text{sp}}(5)$	$2^{12} \cdot 3^3 \cdot 5^7 \cdot 29^3 / 7^5$
7.56.1.2	7	$\subsetneq N_{\text{ns}}(7)$	$3^3 \cdot 5 \cdot 7^5 / 2^7$
7.112.1.2	7	$-I \notin H$	$y^2 + xy + y = x^3 - x^2 - 2680x - 50053$ $y^2 + xy + y = x^3 - x^2 - 131305x + 17430697$
11.60.1.3	11	$\subsetneq B(11)$	$-11 \cdot 131^3$
11.120.1.8	11	$-I \notin H$	$y^2 + xy + y = x^3 + x^2 - 30x - 76$
11.120.1.9	11	$-I \notin H$	$y^2 + xy = x^3 + x^2 - 2x - 7$
11.60.1.4	11	$\subsetneq B(11)$	-11^2
11.120.1.3	11	$-I \notin H$	$y^2 + xy = x^3 + x^2 - 3632x + 82757$
11.120.1.4	11	$-I \notin H$	$y^2 + xy + y = x^3 + x^2 - 305x + 7888$
13.91.3.2	13	$S_4(13)$	$2^4 \cdot 5 \cdot 13^4 \cdot 17^3 / 3^{13}, -2^{12} \cdot 5^3 \cdot 11 \cdot 13^4 / 3^{13}$ $2^{18} \cdot 3^3 \cdot 13^4 \cdot 127^3 \cdot 139^3 \cdot 157^3 \cdot 283^3 \cdot 929 / (5^{13} \cdot 61^{13})$
17.72.1.2	17	$\subsetneq B(17)$	$-17 \cdot 373^3 / 2^{17}$
17.72.1.4	17	$\subsetneq B(17)$	$-17^2 \cdot 101^3 / 2$
37.114.4.1	37	$\subsetneq B(37)$	$-7 \cdot 11^3$
37.114.4.2	37	$\subsetneq B(37)$	$-7 \cdot 137^3 \cdot 2083^3$

Table 1. All known exceptional groups, j -invariants, and points of prime power level.

U N S O L V E D
mysteries

Arithmetically maximal level ℓ^n groups with $\ell \leq 13$ with $X_H(\mathbb{Q})$ **unknown**.

label	level	group	genus
27.243.12.1	3^3	$N_{\text{ns}}(3^3)$	12
25.250.14.1	5^2	$N_{\text{ns}}(5^2)$	14
49.1029.69.1	7^2	$N_{\text{ns}}(7^2)$	69
49.147.9.1	7^2	$\langle \left(\begin{smallmatrix} 16 & 6 \\ 20 & 45 \end{smallmatrix} \right), \left(\begin{smallmatrix} 20 & 17 \\ 40 & 36 \end{smallmatrix} \right) \rangle$	9
49.196.9.1	7^2	$\langle \left(\begin{smallmatrix} 42 & 3 \\ 16 & 31 \end{smallmatrix} \right), \left(\begin{smallmatrix} 16 & 23 \\ 8 & 47 \end{smallmatrix} \right) \rangle$	9
121.6655.511.1	11^2	$N_{\text{ns}}(11^2)$	511

Each has **rank = genus**, **rational CM points**, **no rational cusps**, and **no known exceptional points**.

Summary of ℓ -adic images of Galois for non-CM E/\mathbb{Q} .

ℓ	2	3*	5*	7*	11*	13	17*	37*	other*
subgroups	1208	47	25	17	8	12	3	3	1
exceptional	7	0	2	2	6	1	2	2	0
unexceptional	1201	47	23	15	2	11	1	1	1
max level	32	27	25	7	11	13	17	37	1
max index	96	72	120	112	120	91	72	114	1
max genus	3	0	2	1	1	3	1	4	0

Summary of $H \leq \mathrm{GL}_2(\mathbb{Z}_\ell)$ which occur as $\rho_{E,\ell^\infty}(G_{\mathbb{Q}})$ for some non-CM E/\mathbb{Q} .

Starred primes depend on the conjecture that cases (3) and (4) of our theorem do not occur.

In particular, we conjecture that there are 1207, 46, 24, 16, 7, 11, 2, 2 proper subgroups of $\mathrm{GL}_2(\mathbb{Z}_\ell)$ that arise as $\rho_{E,\ell^\infty}(G_{\mathbb{Q}})$ for non-CM E/\mathbb{Q} for $\ell = 2, 3, 5, 7, 11, 13, 17, 37$ and none for any other ℓ .

Applications

Theorem (R. Jones, Rouse, ZB)

- 1 **Arithmetic dynamics:** let $P \in E(\mathbb{Q})$.
- 2 How often is the order of $\tilde{P} \in E(\mathbb{F}_p)$ odd?
- 3 Answer depends on $\rho_{E,2^\infty}(G_{\mathbb{Q}})$.
- 4 Examples: 11/21 (generic), 121/168 (maximal), 1/28 (minimal)

Theorem (Daniels, Lozano-Robledo, Najman, Sutherland)

Classification of $E(\mathbb{Q}(3^\infty))$

Theorem (Gonzalez-Jimenez, Lozano-Robledo)

Classify E/\mathbb{Q} with $\rho_{E,N}(G_{\mathbb{Q}})$ abelian.

Theorem (Rouse–Sutherland–ZB)

Improved algorithms for computing $\rho_{E,n}(G_{\mathbb{Q}})$.

Arithmetically maximal groups

Definition

We say that an open subgroup $H \subseteq \mathrm{GL}_2(\widehat{\mathbb{Z}})$ is **arithmetically maximal** if

- 1 $\det(H) = \widehat{\mathbb{Z}}^\times$ (necessary for \mathbb{Q} -points),
- 2 a conjugate of $\begin{pmatrix} 1 & 0 \\ 0 & -1 \end{pmatrix}$ or $\begin{pmatrix} 1 & 1 \\ 0 & -1 \end{pmatrix}$ lies in H (necessary for \mathbb{R} -points),
- 3 $j(X_H(\mathbb{Q}))$ is finite but $j(X_{H'}(\mathbb{Q}))$ is infinite for $H \subsetneq H' \subseteq \mathrm{GL}_2(\widehat{\mathbb{Z}})$.

Arithmetically maximal groups H arise as maximal subgroups of an H' with $X_{H'}(\mathbb{Q})$ infinite.

Arithmetically maximal groups

Definition

We say that an open subgroup $H \subseteq \mathrm{GL}_2(\widehat{\mathbb{Z}})$ is **arithmetically maximal** if

- 1 $\det(H) = \widehat{\mathbb{Z}}^\times$ (necessary for \mathbb{Q} -points),
- 2 a conjugate of $\begin{pmatrix} 1 & 0 \\ 0 & -1 \end{pmatrix}$ or $\begin{pmatrix} 1 & 1 \\ 0 & -1 \end{pmatrix}$ lies in H (necessary for \mathbb{R} -points),
- 3 $j(X_H(\mathbb{Q}))$ is finite but $j(X_{H'}(\mathbb{Q}))$ is infinite for $H \subsetneq H' \subseteq \mathrm{GL}_2(\widehat{\mathbb{Z}})$.

Arithmetically maximal groups H arise as maximal subgroups of an H' with $X_{H'}(\mathbb{Q})$ infinite.

Theorem (Sutherland–Zywina 2017)

For $\ell = 2, 3, 5, 7, 11, 13$ there are 1208, 47, 23, 15, 2, 11 subgroups $H \leq \mathrm{GL}_2(\widehat{\mathbb{Z}})$ of ℓ -power level with $X_H(\mathbb{Q})$ infinite, and only $H = \mathrm{GL}_2(\widehat{\mathbb{Z}})$ for $\ell > 13$.

This allows us to compute explicit upper bounds on the level and index of arithmetically maximal subgroup of prime power level ℓ and we can then exhaustively enumerate them.

Subgroups of $GL_2(\mathbb{Z}_{13})$

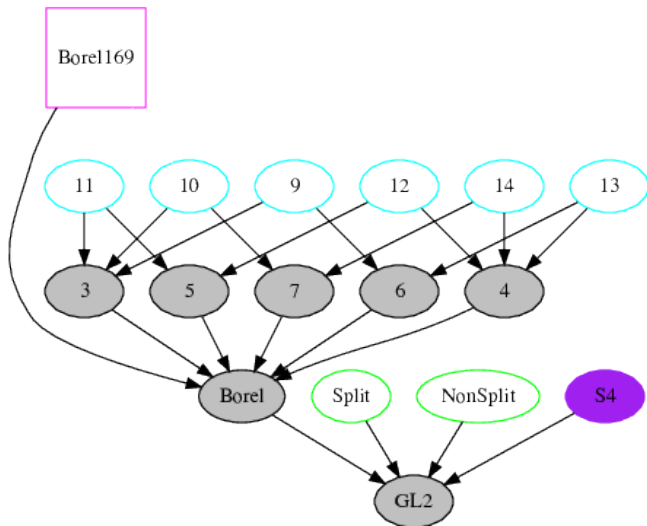

Subgroups of $GL_2(\mathbb{Z}_2)$

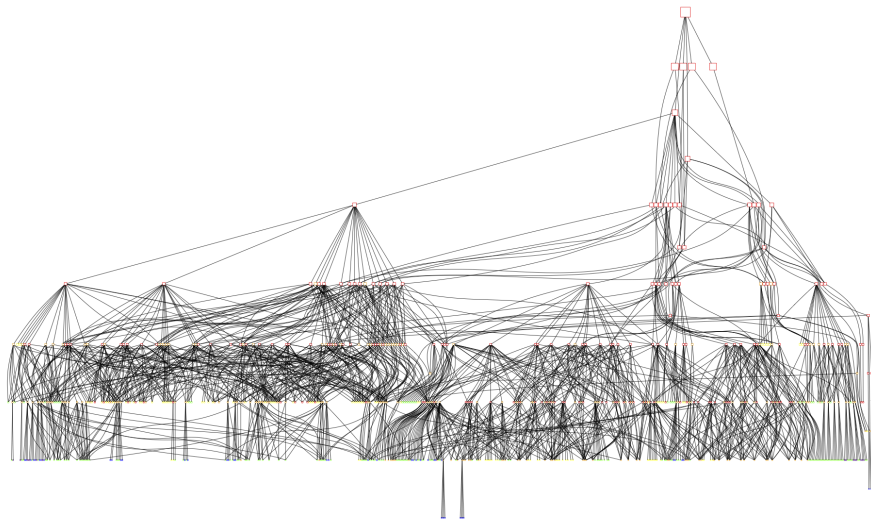

Steps of the proof

- 1 Compute the set \mathcal{S} of **arithmetically maximal** subgroups of ℓ -power level for $\ell \leq 37$ (for all $\ell > 37$ we already know $N_{\text{ns}}(\ell)$ is the only possible exceptional group).
- 2 For $H \in \mathcal{S}$ check for **local obstructions** and compute the **isogeny decomposition** of the Jacobian of X_H and the analytic ranks of all its simple factors.
- 3 For $H \in \mathcal{S}$ **compute equations** for X_H and $j_H: X_H \rightarrow X(1)$ (if needed). In several cases we can prove $X_H(\mathbb{Q})$ is empty without a model for X_H .
- 4 For $H \in \mathcal{S}$ with $-I \in H$ **determine the rational points** in $X_H(\mathbb{Q})$ (if possible). In several cases we are able to exploit recent progress by others ($\ell = 13$ for example).
- 5 For $H \in \mathcal{S}$ with $-I \notin H$ **compute equations** for the universal curve $\mathcal{E} \rightarrow U$, where $U \subseteq X_H$ is the locus with $j(P) \neq 0, 1728, \infty$.

Subgroups of $GL_2(\mathbb{Z}_{11})$

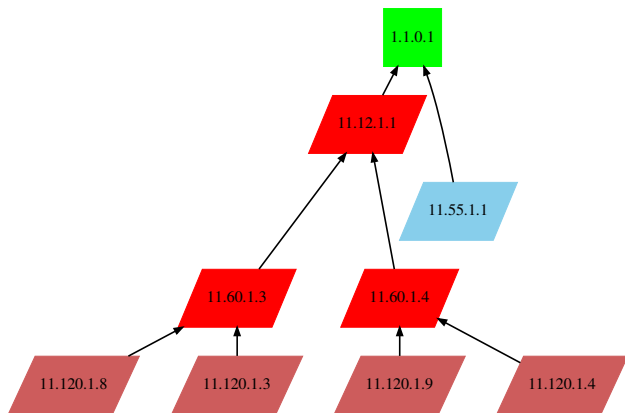

Subgroups of $GL_2(\mathbb{Z}_3)$

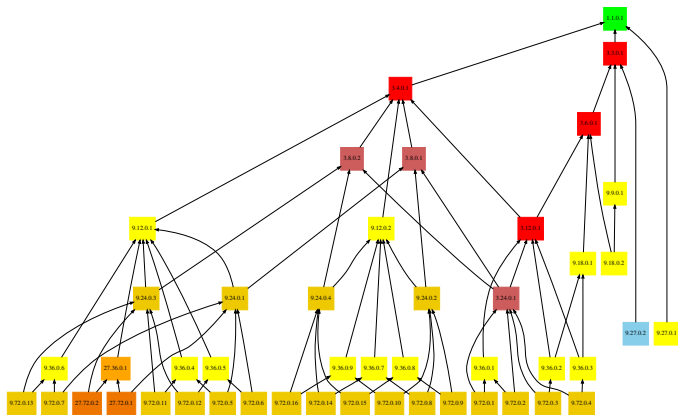

Subgroups of $GL_2(\mathbb{Z}_5)$

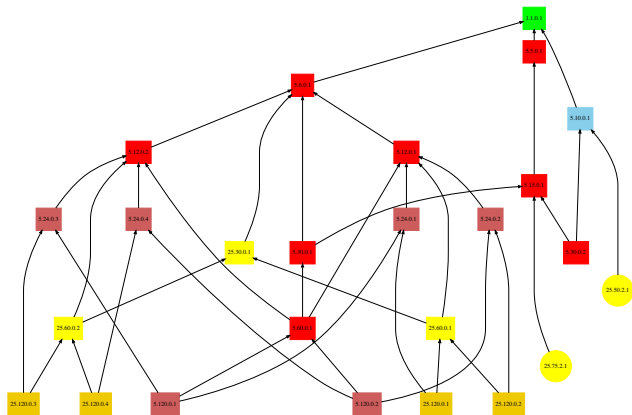

Subgroups of $GL_2(\mathbb{Z}_7)$

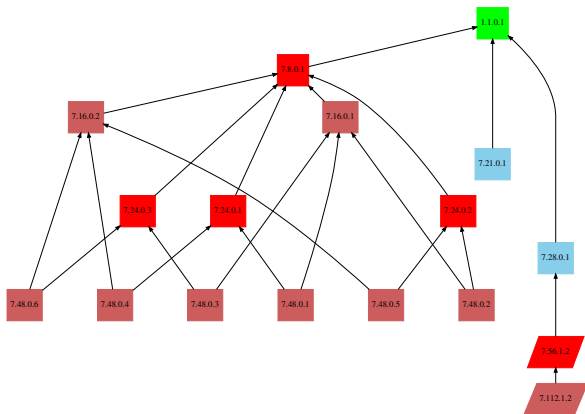

Finding Equations for X_H – Basic idea

- 1 The canonical map $C \hookrightarrow \mathbb{P}^{g-1}$ is given by $P \mapsto [\omega_1(P) : \cdots : \omega_g(P)]$.
- 2 For a general curve, this is an embedding, and the relations are quadratic.
- 3 For a modular curve,

$$M_k(H) \cong H^0(X_H, \Omega^1(\Delta)^{\otimes k/2})$$

given by

$$f(z) \mapsto f(z) dz^{\otimes k/2}.$$

Equations – Example: $X_1(17) \subset \mathbb{P}^4$

Cusp forms

$$q - 11q^5 + 10q^7 + O(q^8)$$

$$q^2 - 7q^5 + 6q^7 + O(q^8)$$

$$q^3 - 4q^5 + 2q^7 + O(q^8)$$

$$q^4 - 2q^5 + O(q^8)$$

$$q^6 - 3q^7 + O(q^8)$$

$$xu + 2xv - yz + yu - 3yv + z^2 - 4zu + 2u^2 + v^2 = 0$$

$$xu + xv - yz + yu - 2yv + z^2 - 3zu + 2uv = 0$$

$$2xz - 3xu + xv - 2y^2 + 3yz + 7yu - 4yv - 5z^2 - 3zu + 4zv = 0$$

Computing models of modular curves

Computations

- We introduce a variety of new techniques and improvements to compute models of various X_H .
- See Rouse's [VaNTAGe talk](#) for more details and interesting examples.
- See Assaf's [recent paper](#) and Zywinina's [BIRS talk](#) for other efficient approaches.

Databases

- [MathOverflow](#): “Where can I find a comprehensive list of equations for small genus modular curves?”
- Modular curves in the [LMFDB \(alpha\)](#)

Explicit methods: highlight reel

- Local methods
 - Chabauty and Elliptic Chabauty
 - Mordell–Weil sieve
 - étale descent
 - Pryms
 - *Equationless étale descent via group theory*
 - *New techniques for computing $\text{Aut } C$*
-
- *Nonabelian Chabauty*
 - **“Equationless” local methods** and **Mordell–Weil sieve**
 - **Greenberg Transforms** (and big computations)
 - **Novel variants of existing techniques**
 - **Modularity of isogeny factors of J_H** (w/ Voight)

Computing $X_H(\mathbb{F}_p)$ “via moduli”

Idea

- 1 One can compute $X_1(N)(\mathbb{F}_p)$ by enumerating elliptic curves over \mathbb{F}_p , then computing their N torsion subgroups.
- 2 (E, P) and $(E, 2P)$ represent different points of $X_1(N)$ (for $N > 3$).
- 3 (E, P) and $(E, -P)$ represent the same point of $X_1(N)$.

Inspiration

- 1 One can do the same for $X_0(N)(\mathbb{F}_p)$ and isogenies.
- 2 Ogg used this idea to classify p for which $X_0(p)$ is hyperelliptic.

Deligne–Rapoport 1973

The **modular curves** X_H and Y_H are coarse spaces for the stacks \mathcal{M}_H and \mathcal{M}_H^0 that parameterize elliptic curves E with **H -level structure**, by which we mean an equivalence class $[\iota]_H$ of isomorphisms $\iota: E[N] \rightarrow \mathbb{Z}(N)^2$, where $\iota \sim \iota'$ if $\iota = h \circ \iota'$ for some $h \in H$.

Stack vs coarse space

$$\mathcal{M}_H^0(\bar{k}) = Y_H(\bar{k}) \text{ and } Y_H(k) = Y_H(\bar{k})^{G_k}$$

In practice

- $Y_H(\bar{k}) = \{(j(E), \alpha) : \alpha = Hg\mathcal{A}_E\}$ with $\mathcal{A}_E := \{\varphi_N : \varphi \in \text{Aut}(E_{\bar{k}})\}$.
- $X_H^\infty(k) = \{\alpha \in H \backslash \text{GL}_2(N)/U(N) : \alpha^{\chi_N(G_k)} = \alpha\}$ where $U(N) := \langle \begin{pmatrix} 1 & \\ 0 & 1 \end{pmatrix}, -1 \rangle$.
- To compute $\#X_H(\mathbb{F}_q) = \#Y_H(\mathbb{F}_q) + \#X_H^\infty(\mathbb{F}_q)$ count double cosets fixed by $G_{\mathbb{F}_q}$.

See Drew's [Slides](#) for a nice summary of the implementation.

Arithmetically maximal H with $\#X_H(\mathbb{F}_p) = 0$ for some p

label	level	generators	p	rank	genus
16.48.2.17	2^4	$\begin{pmatrix} 11 & 9 \\ 4 & 13 \end{pmatrix}, \begin{pmatrix} 13 & 5 \\ 4 & 11 \end{pmatrix}, \begin{pmatrix} 1 & 9 \\ 12 & 7 \end{pmatrix}, \begin{pmatrix} 1 & 9 \\ 0 & 5 \end{pmatrix}$	3, 11	0	2
27.108.4.5	3^3	$\begin{pmatrix} 4 & 25 \\ 6 & 14 \end{pmatrix}, \begin{pmatrix} 8 & 0 \\ 3 & 1 \end{pmatrix}$	7, 31	0	4
25.150.4.2	5^2	$\begin{pmatrix} 7 & 20 \\ 20 & 7 \end{pmatrix}, \begin{pmatrix} 22 & 2 \\ 13 & 22 \end{pmatrix}$	2	0	4
25.150.4.7	5^2	$\begin{pmatrix} 24 & 24 \\ 0 & 18 \end{pmatrix}, \begin{pmatrix} 2 & 5 \\ 0 & 23 \end{pmatrix}$	3, 23	4	4
25.150.4.8	5^2	$\begin{pmatrix} 8 & 4 \\ 0 & 23 \end{pmatrix}, \begin{pmatrix} 16 & 7 \\ 0 & 8 \end{pmatrix}$	2	0	4
25.150.4.9	5^2	$\begin{pmatrix} 2 & 0 \\ 0 & 8 \end{pmatrix}, \begin{pmatrix} 3 & 18 \\ 0 & 14 \end{pmatrix}$	2	0	4
49.168.12.1	7^2	$\begin{pmatrix} 39 & 6 \\ 36 & 24 \end{pmatrix}, \begin{pmatrix} 11 & 9 \\ 24 & 2 \end{pmatrix}$	2	3	12
13.84.2.2	13	$\begin{pmatrix} 3 & 7 \\ 0 & 8 \end{pmatrix}, \begin{pmatrix} 12 & 4 \\ 0 & 12 \end{pmatrix}$	2	0	2
13.84.2.3	13	$\begin{pmatrix} 9 & 2 \\ 0 & 7 \end{pmatrix}, \begin{pmatrix} 4 & 4 \\ 0 & 7 \end{pmatrix}$	3	0	2
13.84.2.4	13	$\begin{pmatrix} 8 & 12 \\ 0 & 10 \end{pmatrix}, \begin{pmatrix} 8 & 3 \\ 0 & 9 \end{pmatrix}$	2	0	2
13.84.2.6	13	$\begin{pmatrix} 9 & 0 \\ 0 & 4 \end{pmatrix}, \begin{pmatrix} 11 & 3 \\ 0 & 10 \end{pmatrix}$	3	0	2

Decomposing the Jacobian of X_H

Let H be an open subgroup of $GL_2(\widehat{\mathbb{Z}})$ of level N .

Let J_H denote the Jacobian of X_H .

Theorem (Rouse–Sutherland–Voight–ZB 2021)

Each **simple factor** A of J_H is **isogenous** to A_f for a weight-2 eigenform f on $\Gamma_0(N^2) \cap \Gamma_1(N)$.

Corollary (Kolyvagin's theorem)

If A is an **isogeny factor** of X_H , and if the **analytic rank** of A is **zero**, then $A(\mathbb{Q})$ is finite.

Corollary (Decomposition)

We can **decompose** J_H up to isogeny using linear algebra and point-counting.

Mordell–Weil sieve

- Let X be a **curve** and A be an **abelian variety**.

$$\begin{array}{c} X(\mathbb{Q}) \\ \downarrow \\ X(\mathbb{F}_p) \end{array}$$

- If $X(\mathbb{F}_p)$ is **empty** for some p then $X(\mathbb{Q})$ is **empty**.

Mordell–Weil sieve

- Let X be a **curve** and A be an **abelian variety**.

$$\begin{array}{ccc} X(\mathbb{Q}) & \longrightarrow & A(\mathbb{Q}) \\ \downarrow & & \downarrow \beta \\ X(\mathbb{F}_p) & \xrightarrow{\pi} & A(\mathbb{F}_p). \end{array}$$

- If $X(\mathbb{F}_p)$ is **empty** for some p then $X(\mathbb{Q})$ is **empty**.
- If $\text{im } \pi \cap \text{im } \beta$ is **empty** then $X(\mathbb{Q})$ is **empty**.

Mordell–Weil sieve

- Let X be a **curve** and A be an **abelian variety**.

$$\begin{array}{ccc} X(\mathbb{Q}) & \longrightarrow & A(\mathbb{Q}) \\ \downarrow & & \downarrow \beta \\ \prod_{p \in S} X(\mathbb{F}_p) & \xrightarrow{\pi_S} & \prod_{p \in S} A(\mathbb{F}_p). \end{array}$$

- If $X(\mathbb{F}_p)$ is **empty** for some p then $X(\mathbb{Q})$ is **empty**.
- If $\text{im } \pi \cap \text{im } \beta$ is **empty** then $X(\mathbb{Q})$ is **empty**.
- This is explicit and is implemented in Magma.

An equationless sieve for the group $121 \cdot 605 \cdot 41 \cdot 1$

The curve X_H has **local points everywhere**, and analytic **rank = genus = 41**.

$H(11) \subset N_{\text{ns}}(11)$, so X_H maps to $X_{\text{ns}}^+(11)$, which is an elliptic curve of rank 1.

$$\begin{array}{ccc} X_H(\mathbb{Q}) & \longrightarrow & X_{\text{ns}}^+(11)(\mathbb{Q}) \cong \langle R \rangle \cong \mathbb{Z} \\ \downarrow & & \downarrow \beta \\ \prod_{p \in S} X_H(\mathbb{F}_p) & \xrightarrow{\pi_S} & \prod_{p \in S} X_{\text{ns}}^+(11)(\mathbb{F}_p) \end{array}$$

- For $p = 13$ the image of any point in $Y_H(\mathbb{Q})$ maps to nR with $n \equiv 1, 5 \pmod{7}$.
- For $p = 307$ any point in $Y_H(\mathbb{Q})$ maps to nR with $n \equiv 2, 3, 4, 7, 10, 13 \pmod{14}$.
- Therefore $Y_H(\mathbb{Q}) = \emptyset$ (and in fact $X_H(\mathbb{Q}) = \emptyset$; there are no rational cusps).
- A point of $X_{\text{ns}}^+(11)(\mathbb{F}_p)$ corresponds to E with $\rho_{E,11}(G_{\mathbb{F}_p}) \subset N_{\text{ns}}(11)$ and lifts to a point of $X_H(\mathbb{F}_p)$ if and only if $\rho_{E,121}(G_{\mathbb{F}_p}) \subset H(121)$.

Gargantuan models of modular curves

- We computed canonical models (over \mathbb{Q}) for $27.729.43.1$ (resp. $25.625.36.1$).
- We use these models to prove that X_H has no \mathbb{Q}_3 (resp. \mathbb{Q}_5) points as follows.
- These models have very bad reduction at $p = 3$ (resp. 5). (They're not even flat!)
- $X_H(\mathbb{F}_p) \neq \emptyset$ for all p , but $X_H(\mathbb{Z}/p^2\mathbb{Z}) = \emptyset$ for $p = 3$ (resp. 5).
- The “Greenberg transform” (i.e., the “Wittferential tangent space” of Buium) is adjoint to Witt vectors: $X_H^{(1)}(\mathbb{F}_p) = X_H(\mathbb{Z}/p^2\mathbb{Z})$.
- The fibers of the map $X_H^{(1)} \rightarrow X_H$ have no \mathbb{F}_p points.

Subgroups of $GL_2(\mathbb{Z}_2)$

